

lubrication systems



# DPX

## PROGRESSIVE DIVIDERS

**High quality and High tolerance  
Unbeatable combination of performance and  
convenience**

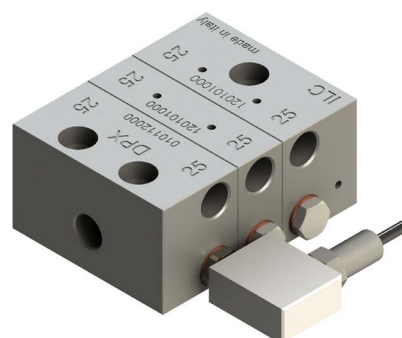
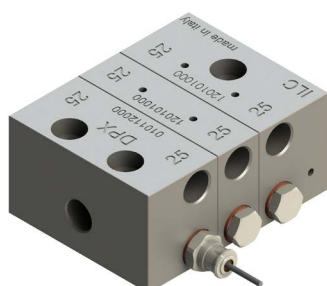
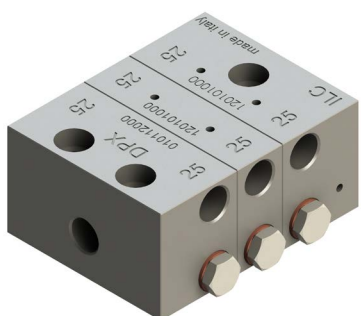

# INDEX OF CONTENTS

General description	3
Benefits and Technical data	4
Functioning	6
Outlets	7
Blocks ordering codes	8
Elements ordering codes	9
Junctions & filters	12
Cycle control	13
Cycle control (ATEX)	15
Shut-Off valve	16
Pressure sensor & bridge junction	17
Nylon junctions	18
Metal junctions	19

## Features and general description

The DPX system doses lubricant with a progressive piston movement. Every piston controls the following one in a sequence obtained through a single delivery flow.

This system is highly qualified for dosing oil and grease to one or more journals or bearing. Each piston is in series with the component before or the one after it and therefore malfunctioning of one of these causes stopping of the sequence and consequently inhibiting of the system.

This inhibition occurs also during any external clogging or when unused outlet are plugged.

In order to check the entire distribution process, it is enough to apply a single visual or electrical control.

The pump flowrate is fractionable when the doser blocks are arranged in cascade. A master block can supply one or more progressive doser. Those doser can, in turn, supply another block of dosers.

It is recommended to have no more than two cascades after the master for compressibility and aerations reasons. Any further addition can cause irregular flow, especially using grease or low flow rates.

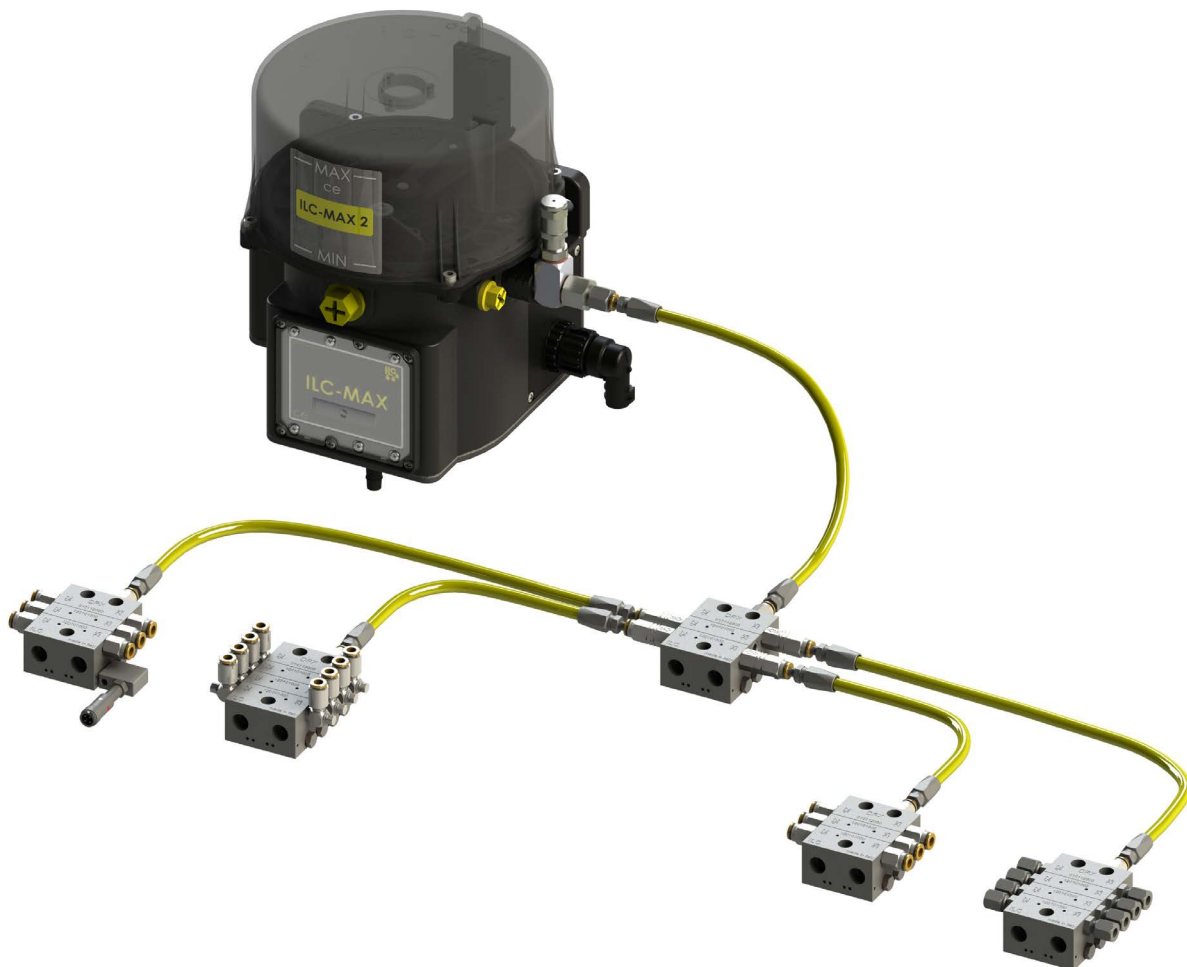

**DPX benefits**

Positive discharge of measured quantity of lubricant guaranteed

Suitable for system functioning control

Long operational life assured by a careful selection of high grade material and strict quality control.

Operation monitor with indicators and/or contact plugs

system design flexibility due to large range and combination of sizes

**Data sheet**

Discharge / Stroke for each outlet	25 mm <sup>3</sup> - 45 mm <sup>3</sup> - 75 mm <sup>3</sup> - 105 mm <sup>3</sup>
Elements number	Da 3 a 12
Operating pressure	da 15 a 300 Bar
Operating temperature	da -20° C a + 100° C
Body distributor	Acciaio galvanizzato Zi-Ni (liberi da Cr-V)
Number of cycle/minute	Max 300/min
Inlet	1/8" BSP
Outlets	M10 x 1
Mounting screws	M5 x 30
Lubricants	Olio minerale 46 cSt - Grasso Max NLGI-2
Control elements	Visivi ed elettrici per segnalazione di ciclo e di sovraPressure
Main lines	Tubazioni Ø 8-6
Secondary lines	Tubazioni Ø 6-4

Functioning

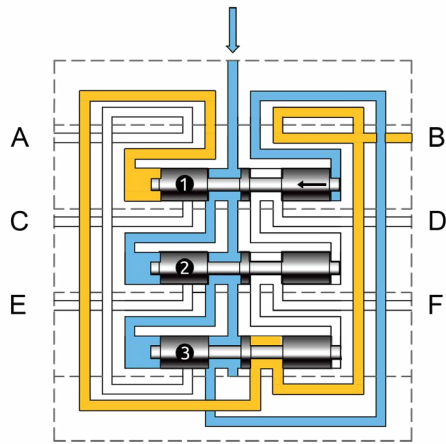

A

Lubricant flow pressure (blue) moves piston **1** to the left allowing lubricant discharge (yellow) from **B**.

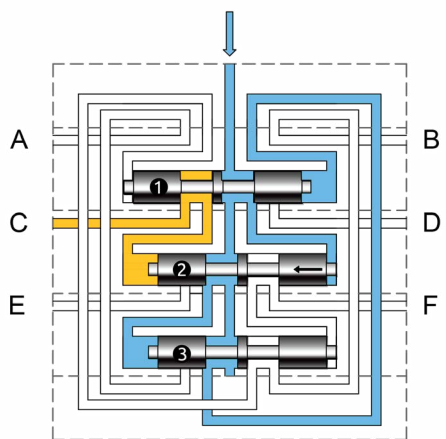

B

When piston **1** reaches its limit, lubricant flow pressure (blue) operates on piston **2**. Lubricant volume (yellow) discharge from **C**.

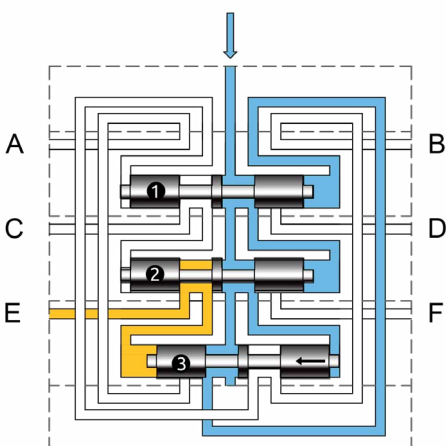

C

When piston **2** reaches its limit, lubricant flow pressure (blue) operates on piston **3**. Lubricant volume (yellow) discharge from **E**.

Functioning

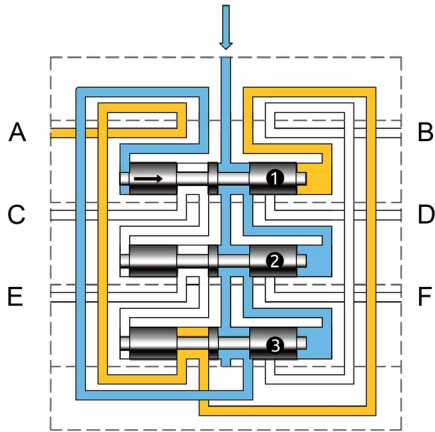

When piston **3** reaches its limit, lubricant flow pressure (blue) operates on piston **1**. Lubricant volume (yellow) discharge from **A**.

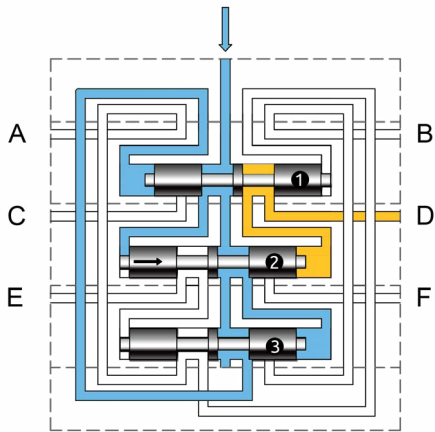

When piston **1** reaches its limit, lubricant flow pressure (blue) operates on piston **2**. Lubricant volume (yellow) discharge from **D**.

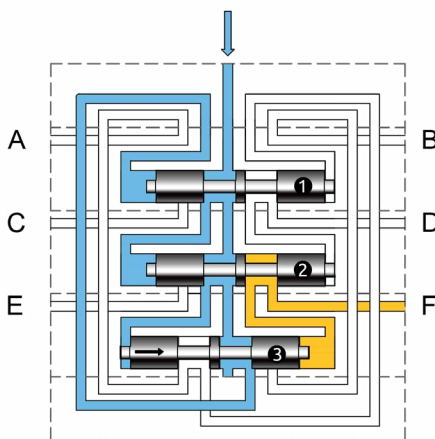

When piston **2** reaches its limit, lubricant flow pressure (blue) operates on piston **3**. Lubricant volume (yellow) discharge from **F**. The system is ready for a new cycle.

Outlets

Outlets union/separation

Each divider piston is arranged in order to feed 1 or 2 outlets.

When the separation dowel is inserted (see Fig.1), the discharge is carried out in both sides.

When the dowel is not inserted (see Fig. 2), the double discharge is carried out in one of the two available outlets.

If it is necessary to use a single outlet, extract the sphere (A92.089005), besides the separation dowel (UNI5925 M4X6) and insert a plug (A73.087010 + A92.127006) in the outlet no more used.

The dividers are supplied with the separation dowel inserted and the two outlets open as standard.

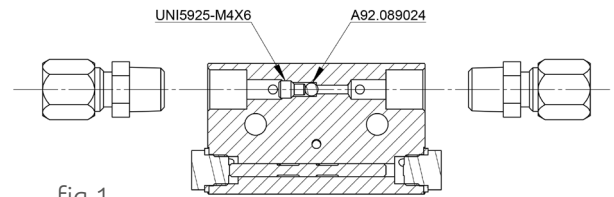

fig.1

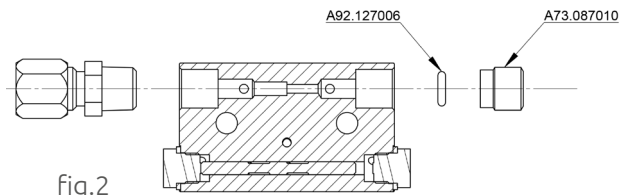
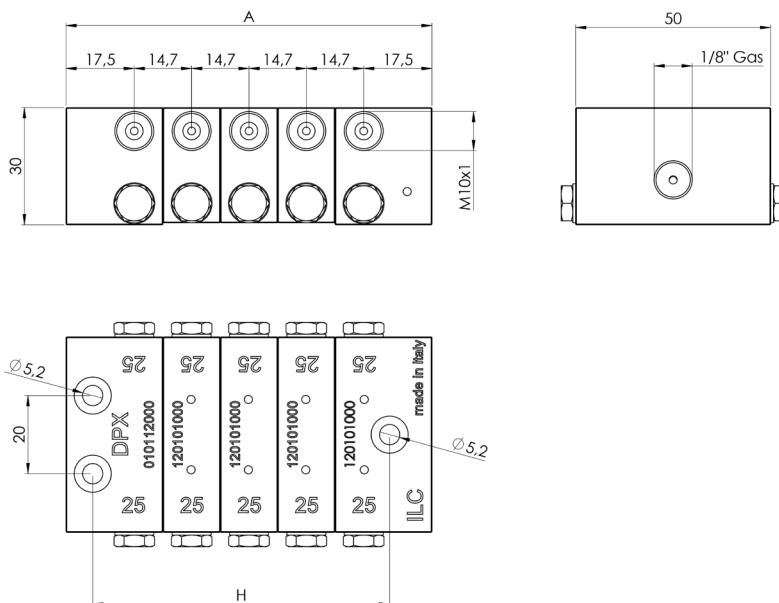

fig.2

**Important!**

It is not possible to shut both outlets of a piston. All the operations explained have to be made in a clean environment.

Dimensions



Outlets	A [mm]	H [mm]
6	64,4	46,7
8	79,1	61,4
10	93,8	76,1
12	108,5	90,8
14	123,2	105,5
16	137,9	120,2
18	152,6	134,9
20	167,3	149,6
22	182,0	164,3
24	196,7	179

Blocks ordering codes

Pistons	Standard	With visual pin	With inductive sensor (cabled)	With inductive sensor M8	With inductive sensor M12	Con Micro switch
3	2.1N.03	2.2V.03	2.3I.03	2.3I.03.M8	2.3I.03.M12	2.4M.03
4	2.1N.04	2.2V.04	2.3I.04	2.3I.04.M8	2.3I.04.M12	2.4M.04
5	2.1N.05	2.2V.05	2.3I.05	2.3I.05.M8	2.3I.05.M12	2.4M.05
6	2.1N.06	2.2V.06	2.3I.06	2.3I.06.M8	2.3I.06.M12	2.4M.06
7	2.1N.07	2.2V.07	2.3I.07	2.3I.07.M8	2.3I.07.M12	2.4M.07
8	2.1N.08	2.2V.08	2.3I.08	2.3I.08.M8	2.3I.08.M12	2.4M.08
9	2.1N.09	2.2V.09	2.3I.09	2.3I.09.M8	2.3I.09.M12	2.4M.09
10	2.1N.10	2.2V.10	2.3I.10	2.3I.10.M8	2.3I.10.M12	2.4M.10
11	2.1N.11	2.2V.11	2.3I.11	2.3I.11.M8	2.3I.11.M12	2.4M.11
12	2.1N.12	2.2V.12	2.3I.12	2.3I.12.M8	2.3I.12.M12	2.4M.12

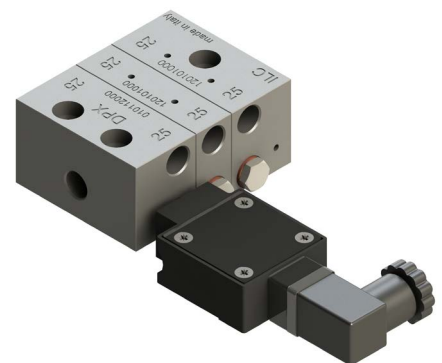
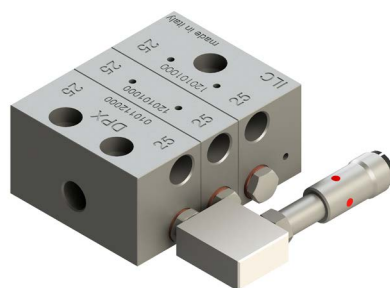
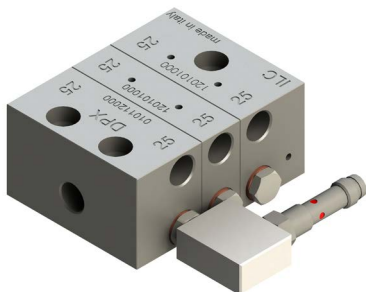
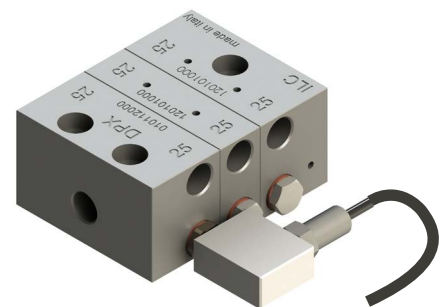
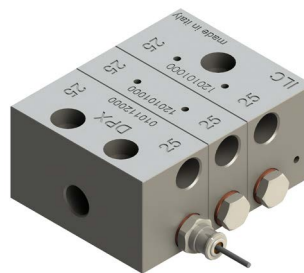
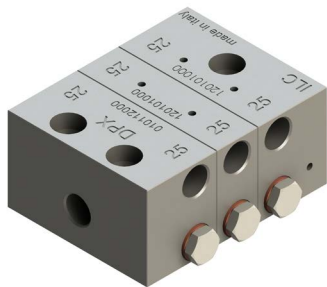



Standard



Discharge	Inlet valve section	Valve section	End valve section
25 mm <sup>3</sup>	2.A.025.D.1N	2.B.025.D.1N	2.C.025.D.1N
45 mm <sup>3</sup>	2.A.045.D.1N	2.B.045.D.1N	2.C.045.D.1N
75 mm <sup>3</sup>	2.A.075.D.1N	2.B.075.D.1N	2.C.075.D.1N
105 mm <sup>3</sup>	2.A.105.D.1N	2.B.105.D.1N	2.C.105.D.1N

With visual pin



Discharge	Inlet valve section	Valve section	End valve section
45 mm <sup>3</sup>	2.A.045.D.2V	2.B.045.D.2V	2.C.045.D.2V
75 mm <sup>3</sup>	2.A.075.D.2V	2.B.075.D.2V	2.C.075.D.2V
105 mm <sup>3</sup>	2.A.105.D.2V	2.B.105.D.2V	2.C.105.D.2V

With inductive sensor (cabled)



Discharge	Inlet valve section	Valve section	End valve section
45 mm <sup>3</sup>	2.A.045.D.3I	2.B.045.D.3I	2.C.045.D.3I
75 mm <sup>3</sup>	2.A.075.D.3I	2.B.075.D.3I	2.C.075.D.3I
105 mm <sup>3</sup>	2.A.105.D.3I	2.B.105.D.3I	2.C.105.D.3I

With inductive sensor M8

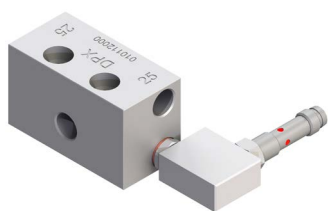

Discharge	Inlet valve section	Valve section	End valve section
45 mm <sup>3</sup>	2.A.045.D.3I.M8	2.B.045.D.3I.M8	2.C.045.D.3I.M8
75 mm <sup>3</sup>	2.A.075.D.3I.M8	2.B.075.D.3I.M8	2.C.075.D.3I.M8
105 mm <sup>3</sup>	2.A.105.D.3I.M8	2.B.105.D.3I.M8	2.C.105.D.3I.M8

With inductive sensor M12



Discharge	Inlet valve section	Valve section	End valve section
45 mm <sup>3</sup>	2.A.045.D.3I.M12	2.B.045.D.3I.M12	2.C.045.D.3I.M12
75 mm <sup>3</sup>	2.A.075.D.3I.M12	2.B.075.D.3I.M12	2.C.075.D.3I.M12
105 mm <sup>3</sup>	2.A.105.D.3I.M12	2.B.105.D.3I.M12	2.C.105.D.3I.M12

Con Micro switch



Discharge	Inlet valve section	Valve section	End valve section
45 mm <sup>3</sup>	2.A.045.D.4M	2.B.045.D.4M	2.C.045.D.4M
75 mm <sup>3</sup>	2.A.075.D.4M	2.B.075.D.4M	2.C.075.D.4M
105 mm <sup>3</sup>	2.A.105.D.4M	2.B.105.D.4M	2.C.105.D.4M

Tie-rods ordering codes

Elements	A[mm]	Code
3	45	2.TR.03
4	60	2.TR.04
5	75	2.TR.05
6	90	2.TR.06
7	105	2.TR.07
8	120	2.TR.08
9	135	2.TR.09
10	150	2.TR.10
11	165	2.TR.11
12	180	2.TR.12

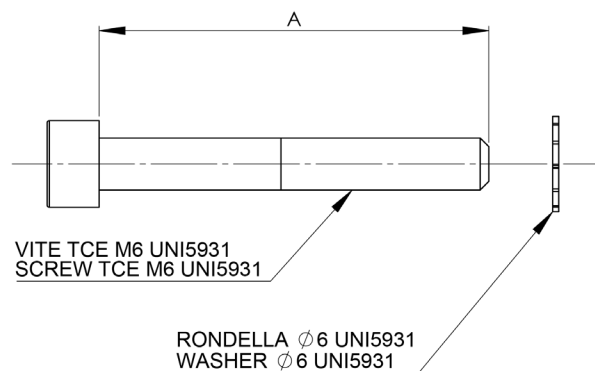

Banjo with grease nipple

03.355.5/03.355.6

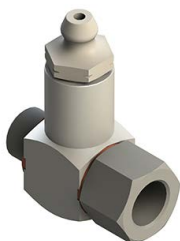

Banjo junctions are placed on a progressive distributor inset. Their job is to let us use a manual or hydraulic pump when the main pump does not work.

Code	Thread
03.355.5	1/8" BSP (ingresso)
03.355.6	M10 x 1 (uscite)

Inlet filter

07.261.1/07.260.3

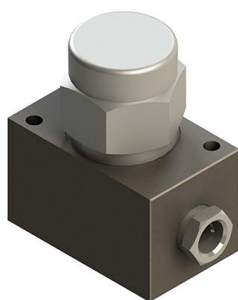

These strainer prevent the lubricant lines from being obstructed by impurities.

Supply joints included.  
Plug **1/4" BSP (F)**

Code	Filtration rate
07.261.1	300 μ
07.260.3	125 μ

Inlet filter 70 μ

07.270.5

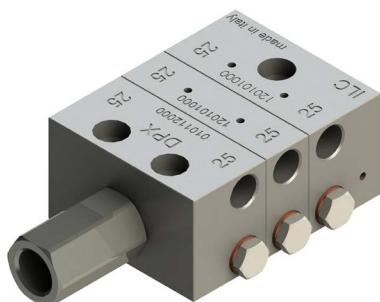

These strainer prevent the lubricant lines from being obstructed by impurities.

Filtration rate **70 μ**  
Plug **1/4" BSP (F)**

Ordering code 07.270.5

Micro switch

49.050.2

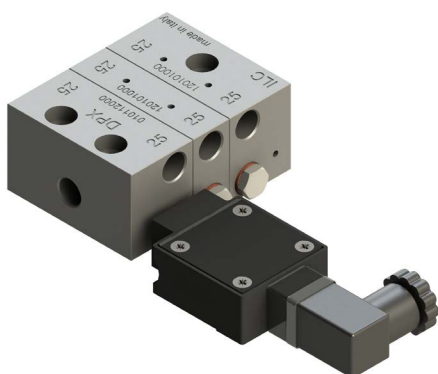

SHUT OFF valves EV-2 are made of a special “NC” 2-ways solenoid valve and of a modular base that can be directly assembled on the DPX inlet.

**EV-2** valve is the essential element in order to transform a standard progressive system into a **sectioned system**.

Features

Micro switch	5 A - 250 V AC 0.4 A - 125 DC
Connections	Connettore 3P
Enclosure	IP-65
temperature	da -25° C a +85° C

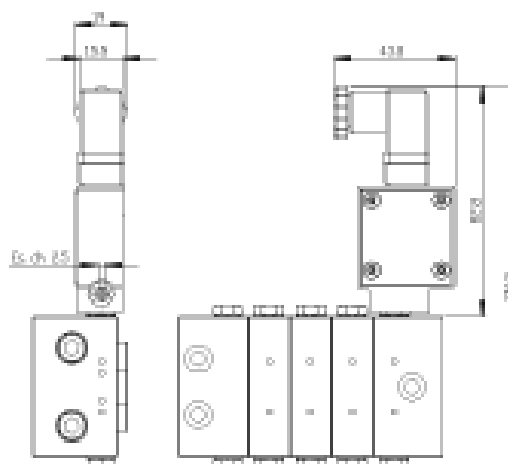
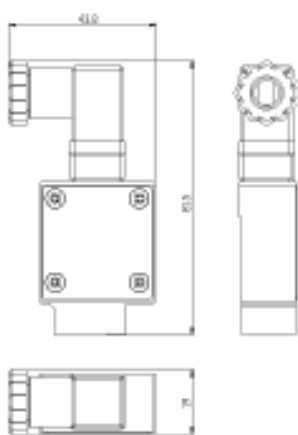

Ordering codes

Pistons	Code	Pistons	Code
3	2.4M.03	8	2.4M.08
4	2.4M.04	9	2.4M.09
5	2.4M.05	10	2.4M.10
6	2.4M.06	11	2.4M.11
7	2.4M.07	12	2.4M.12

Electrical connection

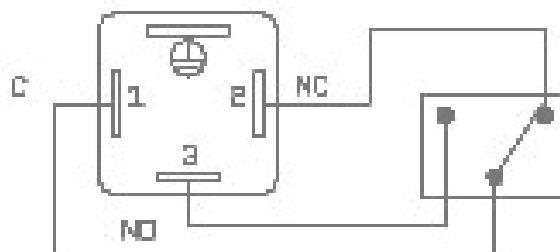

Visual pin



The visual pin shows the piston movement, monitoring the proper operation of the entire system.

Inductive control



In this control a proximity switch is housed in a composite block.

The piston opens and closes the contact as it moves into its operational seat.

They are usually used in cycle control systems where they can count up to 300 movement for minute.

Electrical data

Voltage	6-30 V DC
Outlet current	Max 200 mA
Current	< 22 mA
Operating temperature	from - 25 °C to +70 °C
Protection	IP 67
Sensor housing	Stainless steel
Sensor block	Pet-G
Connection	M8x1 - M12x1

Connection cable codes

Length	M8x1 Stright	M12x1 90°	M12x1 Stright
5 m	A91.111227	A91.111441	A91.111349
10 m	A91.111348	A91.111552	A91.111296
15 m	A91.111393	A91.111318	A91.111350

Sensor kit codes (PNP NA)

With cable	49.052.5
M8 x 1	49.052.7
M12 x 1	49.052.9

Electrical connection

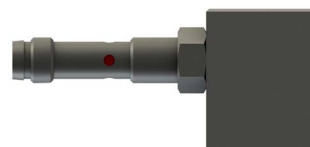
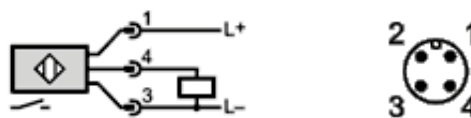

Group II Category 1D-1G/2G

Electrical data

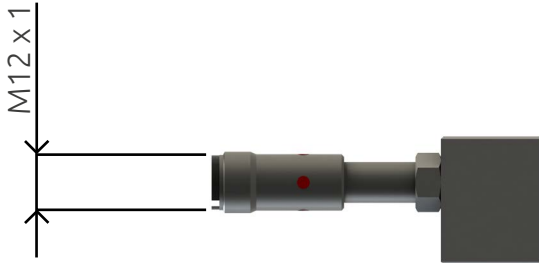

Electrical Model	Certified intrinsically safe circuits with maximum values $U = 15\text{ V} / I = 50\text{ mA} / P = 120\text{ mW}$
Nominal voltage	8,2 DC; (1k $\Omega$ )
Voltage	V 7,5...30 DC; to be used outside potentially explosive areas
Current	< 1 blocker; (> 2,1 mA conductore)
Contact	NC
Current capacity [MA]	< 30; to be used outside potentially explosive areas
Temperature	-20...70
Protection	IP 67

Ordering codes

Electrical connection

Inductive control	49.052.9.ATX.1GD
Connection cable (2 m)	A91.111519
Connettore cavo 10 m	A91.111520

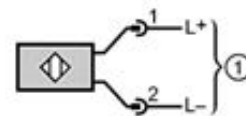

Group II Category 3G-3D

Electrical data

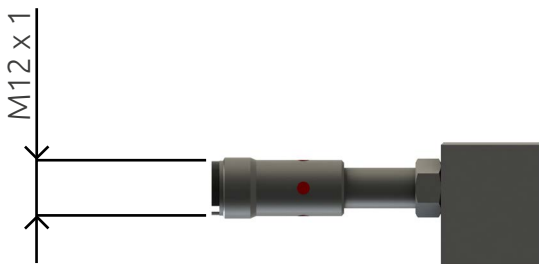

Electrical Model	DC PNP
Nominal voltage	10-36 V DC
Outlet current	MAX 200 mA
Current	< 20 Ma
Temperature	da - 40 °C a + 70 °C
Protection	IP 67
Sensor housing	Stainless steel
Contact	NO

Ordering codes

Electrical connection

Inductive control	49.052.9.ATX
Connection cable (2 m)	A91.111519
Connettore cavo (10 m)	A91.111520

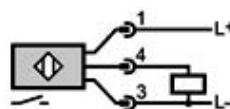

## Shut-Off EV-2

A70.093606/115/230

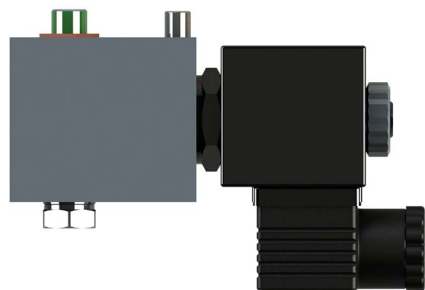

SHUT OFF valves EV-2 are made of a special "NC" 2-ways solenoid valve and of a modular base that can be directly assembled on the DPX inlet.

**EV-2** valve is the essential element in order to transform a standard progressive system into a **sectioned system**.

## Ordering codes

Code	Tension
A70.093606	24 V DC
A70.093606.115	115 V AC
A70.093606.230	230 V AC

## Technical data

Pressure	Max 300 Bar
Lubricant	Olii viscosità min 32 cSt) Grasso max NLGI-1
Temperature	Da -20 °C a +80 °C
Voltage	24 V DC, 115 - 230 V AC 50/60 Hz.
Power	35 W (DC) 8 VA (AC)
Protection	IP54
Inlet	1/4" BSP

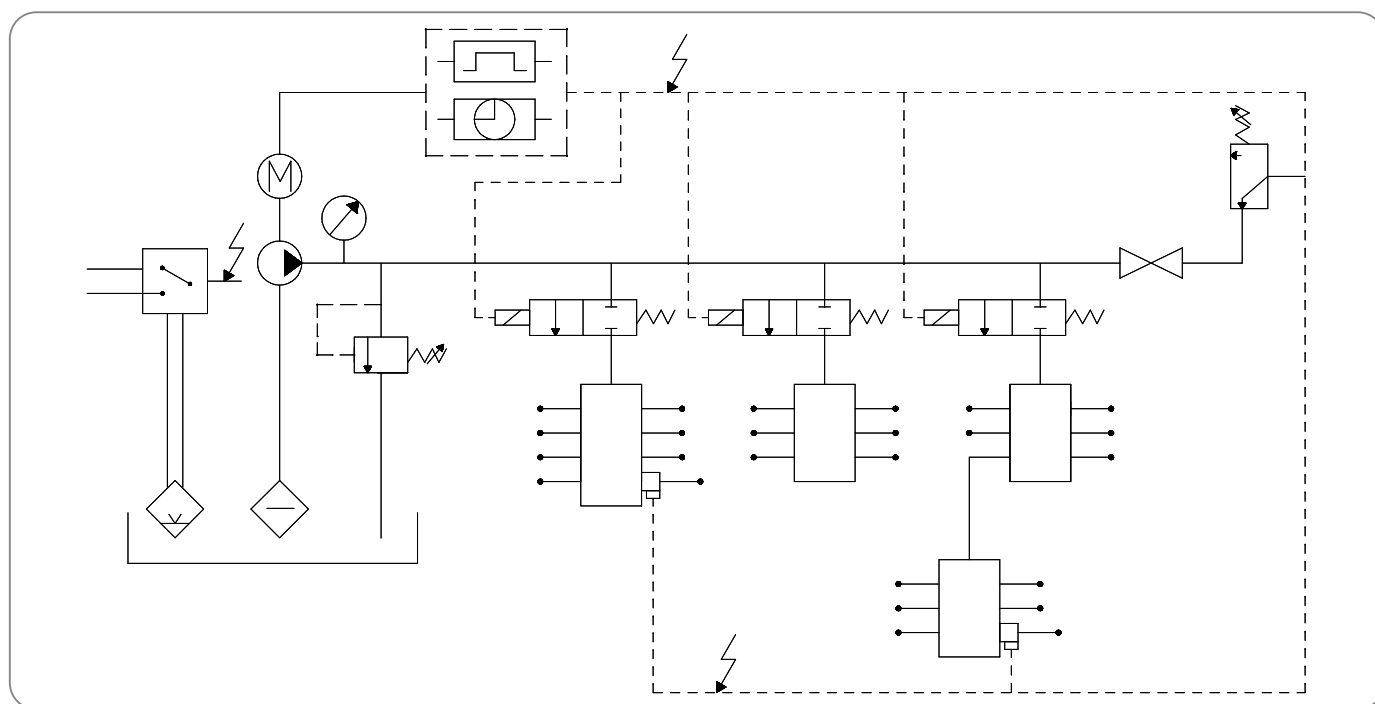



Pressure sensor with memory

09.710.2...7

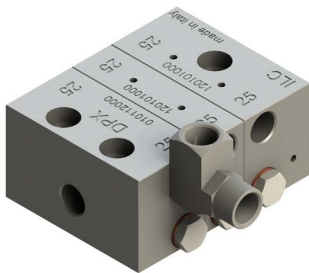
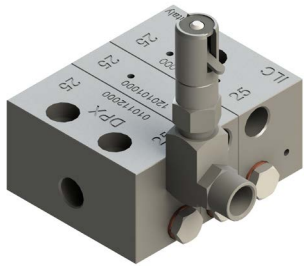

These indicators are usually for overpressure control on primary and secondary lines.

In the eventuality of a pressure higher than expected, the pin indicator moves out. It remains in position until the release lever is manually actuated.

We suggest to discover the reason and the location of the fault before actuating the lever.

Ordering codes

Code	Pressure	Code	Pressure
09.710.2	50 Bar	09.710.5	150 Bar
09.710.3	75 Bar	09.710.6	200 Bar
09.710.4	100 Bar	09.710.7	250 Bar

In order to connect the pressure sensor we need a T junction (**09.600.5**).

Bridge junction

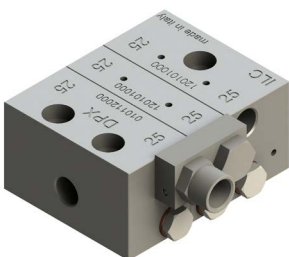
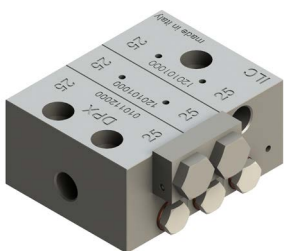



Bridge junctions are used when we want to discharge two outlets from one single point.

Ordering codes



Bridge without outlet	09.600.3.R
Bridge with outlet	09.600.4.R

Inlet connections		
DIN 2353	Pressure	Thread
	500 bar	1/8" BSP
Stright	Code	Ø Tube
	ZZZ.106-004	6 mm
	TW.100525	8 mm
	TW.100528	10 mm
90°	Code	Ø Tube
	ZZZ.106-104	6 mm
	TW.102025	8 mm
	TW.102028	10 mm

Outlet connections		
DIN 2353	Pressure	Thread
	500 bar	M10 x 1
Stright	Code	Ø Tube
	ZZZ.104-003	4 mm
	ZZZ.106-003	6 mm
90°	Code	Ø Tube
	ZZZ.104.103	4 mm
	ZZZ.106-103	6 mm

90° outlet junction requires tie-rods to be completely removed and the elements to be completely separated.

PUSH-IN		
	Pressure	Thread
	250 bar	1/8" BSP
Stright	Code	Ø Tube
	03.256.0	6 mm
90°	Code	Ø Tube
	03.256.6	6 mm

PUSH-IN		
	Pressure	Thread
	250 bar	M10 x 1
Stright	Code	Ø Tube
	03.255.3	4 mm
	03.256.3	6 mm
90°	Code	Ø Tube
	03.255.8	4 mm
	03.256.7	6 mm

Restraint valve		
	Thread M	Thread F
	1/8" BSP	M10 x 1
Ingresso DPX	Code	
	14.050.4	

Restraint valve		
	Thread M	Thread F
	M10 x 1	M10 x 1
Uscita DPX	Code	
	14.050.8	

Ring		
	Pressure	Thread
	250 bar	M10 x 1
Stright	Code	Ø Tube
	04.051.0 06.051.0	4 mm
	04.052.0 06.052.0	6 mm

Inlet connections			Outlet connections		
<b>DIN 2353</b>	Pressure	Thread	<b>DIN 2353</b>	Pressure	Thread
	500 bar	1/8" BSP		500 bar	M10 x 1
<b>Stright</b>	Code	Ø Tube	<b>Stright</b>	Code	Ø Tube
	ZZZ.106-004	6 mm		ZZZ.104-003	4 mm
	TW.100525	8 mm		ZZZ.106-003	6 mm
	TW.100528	10 mm			
<b>90°</b>	Code	Ø Tube	<b>90°</b>	Code	Ø Tube
	ZZZ.106-104	6 mm		ZZZ.104-103	4 mm
	TW.102025	8 mm		ZZZ.106-103	6 mm
	TW.102028	10 mm			
<b>PUSH-IN</b>	Pressure	Thread	<b>PUSH-IN</b>	Pressure	Thread
	250 bar	1/8" BSP		250 bar	M10 x 1
<b>Stright</b>	Code	Ø Tube	<b>Stright</b>	Code	Ø Tube
	03.256.0	6 mm		03.255.3	4 mm
				03.256.3	6 mm
<b>90°</b>	Code	Ø Tube	<b>90°</b>	Code	Ø Tube
	03.256.6	6 mm		03.255.8	4 mm
				03.256.7	6 mm
<b>Restraint valve</b>	Thread M	Thread F	<b>Restraint valve</b>	Thread M	Thread F
	1/8" BSP	M10 x 1		M10 x 1	M10 x 1
<b>Ingresso DPX</b>	Code		<b>Uscita DPX</b>	Code	
	14.050.4			14.050.8	

I.L.C. srl - Via Garibaldi, 149 - 20155 Gorla Minore - Italy  
Phone +39 0331 601697 - Fax +39 0331 602001 - [www.ilclube.com](http://www.ilclube.com) - [info@ilclube.it](mailto:info@ilclube.it)

